

LOKSCHUPPEN/LOKWERKSTATT

FALLER®

LOCOMOTIVE SHED/ENGINE WORKSHOP

ENTREPÔT/GARAGE À LOCOMOTIVES

LOCOMOTIEFLOODS/LOCOMOTIEFGARAGE

Art. Nr. 120159

D

Vor Beginn des Bastelns sollten Sie sich mit den Spritzlingen und der Anleitung vertraut machen. Sollte es einmal vorkommen, dass ein Teil im Bausatz fehlt, kreuzen Sie bitte das fehlende Teil in der Anleitung an und schicken Sie diese bitte an Fa. Gebr. FALLER GmbH, Abt. Kundendienst, kundendienst@faller.de, Kreuzstraße 9, 78148 Gütenbach. Sie erhalten dann umgehend Ersatz. In diesem Bausatz sind einige Kunststoffteile übrig.

GB

Before beginning with the assembly please familiarize yourself with the parts and read the instructions carefully. In case of missing parts please indicate these on the instructions leaflet with a circle and return the leaflet to Gebr. FALLER GmbH, kundendienst@faller.de, Kreuzstraße 9, D-78148 Gütenbach, Germany. You will receive the replacement by return. Some of the parts in this box are not needed to construct the model.

F

Avant de commencer le montage de votre maquette bien lire la notice et repérer les grappes. Si une pièce manque dans une boîte, cochez la pièce correspondante sur la notice et renvoyez-la-nous à Gebr. FALLER GmbH, kundendienst@faller.de, Kreuzstraße 9, D-78148 Gütenbach (R.F.A.). Nous vous ferons parvenir la pièce par retour. Dans cette boîte se trouvent quelques pièces qui ne seront pas utilisées pour le montage.

NL

Vóór het bouwen zou men de gietsstukken en de handleiding moeten bestuderen. Indien onverhoopt een onderdeel aan het bouwpakket ontbreekt, gelieve men het ontbrekende deel in de handleiding aan te kruisen en deze te zenden aan Gebr. FALLER GmbH, kundendienst@faller.de, Kreuzstraße 9, D-78148 Gütenbach. U ontvangt dan omgaand en gratis het ontbrekende onderdeel. Van dit bouwpakket worden enkele kunststof delen niet gebruikt.

Für den Zusammenbau des Modells empfehlen wir folgende FALLER-Artikel (sind nicht im Bausatz enthalten):
For the assembly of the kit we recommend following FALLER products (not included in the kit):
Pour l'assemblage du modèle, nous vous recommandons les articles FALLER suivants (non inclus dans le kit):
Om dit model te bouwen adviseren wij de volgende FALLER producten (maken geen deel uit van deze bouwset):



Art. Nr. 170492
FALLER-EXPERT

Flüssigkleber in Plastikflasche mit Spezialkanüle für feinste Klebstoffdosierung.

Liquid cement in plastic bottle with canule for very fine dosage.

Colle liquide en bouteille plastique avec bec verseur pour un dosage précis.

Vloeibare lijm in plastic-fles met doseerbuisje om nauwkeurig te lijmen.



Art. Nr. 170688
SPEZIAL-SEITENSCHNEIDER

zum gratfreien Abtrennen von feinsten Spritzteilen.
Nur für Polystyrol geeignet.

Special side cutter for cutting off ultra-fine moulded parts without burrs.
Only suitable for polystyrene.

Pince coupante spéciale pour couper sans bavure les pièces miniatures moulées par injection. Convient uniquement au polystyrène.

Speciale zijkniptang voor het braamloos afknippen van de fijnste gietsukdelen. Alleen geschikt voor polystyrol.



Inhalt	Spritzlinge	1	1 x	4	1 x	10	2 x	13	2 x
Contents	Sprues	2	2 x	5	2 x	11	1 x	14	1 x
Contenu	Moulages	3	2 x	7	2 x	12	1 x		
Inhoud	Gietsstukken								

Sa. Nr. 146 684 0

2 Wichtige Hinweise:

Bevor Sie mit der Montage des Modells beginnen, sollten Sie sich zuerst mit den Vorteilen der Modul-Bauweise befassen, die auf der Verpackungsrückseite und in den Abschnitten Variante 1 und Variante 2 der Bauanleitung gezeigt werden.

Das Modulsystem ermöglicht Ihnen durch den Zukauf weiterer Modelle den individuellen Ausbau in Hintereinander- und Parallelbauweise.

Important notice:

Before you start assembling your kit, please familiarise yourself thoroughly with all the advantages of the modular-structure this kit has to offer as shown on the reverse of the packaging and as indicated by variations 1 and 2 in the instructions.

The modular-structure offers you the possibility of buying more models and creating your own individual model by adding-on either as an extension or building-on parallel.

Avis importants:

Avant de commencer l'assemblage de votre modèle, vous devez étudier les avantages de la méthode de construction modulaire indiquée au dos de la boîte ainsi que dans la notice de montage aux variantes 1 et 2.

Le système modulaire vous permet grâce à l'achat d'autres boîtes, de réaliser une construction personnelle avec bâtiments parallèles ou les uns derrière les autres.

Belangrijke aanwijzingen:

Voordat U met de montage van het model begint, zou U zich eerst op de hoogte moeten stellen van de voordelen van de moduul bouwwijze, die op de achterzijde van de verpakking en op de inzetten van de handleiding bij variant 1 en 2 zijn afgebeeld.

Na aanschaf van meer modellen is het door het moduulsysteem mogelijk, de bouw naar eigen inzicht uit te voeren, achter elkaar of parallel.

Variante 1

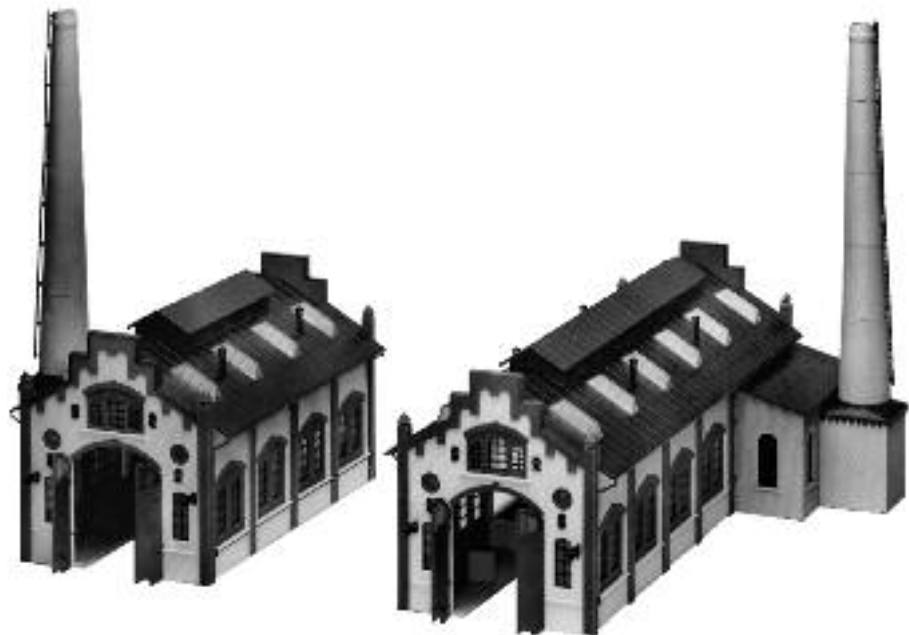

2 x Art. Nr. 120159

Variante 2
2 x Art. Nr. 120159

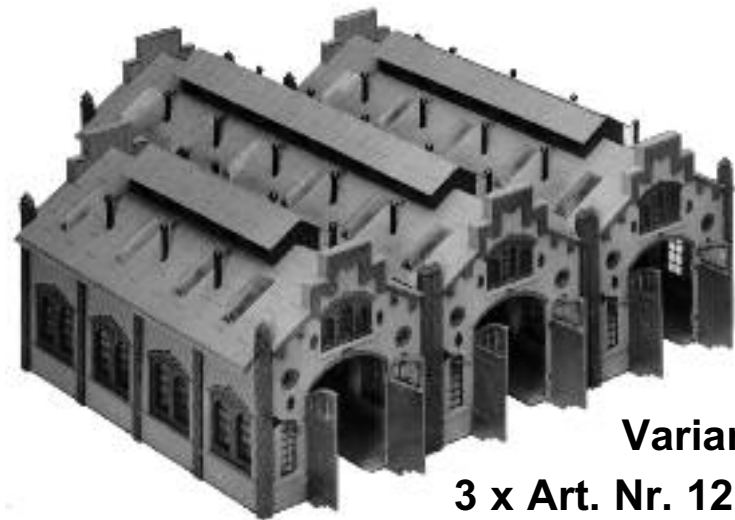
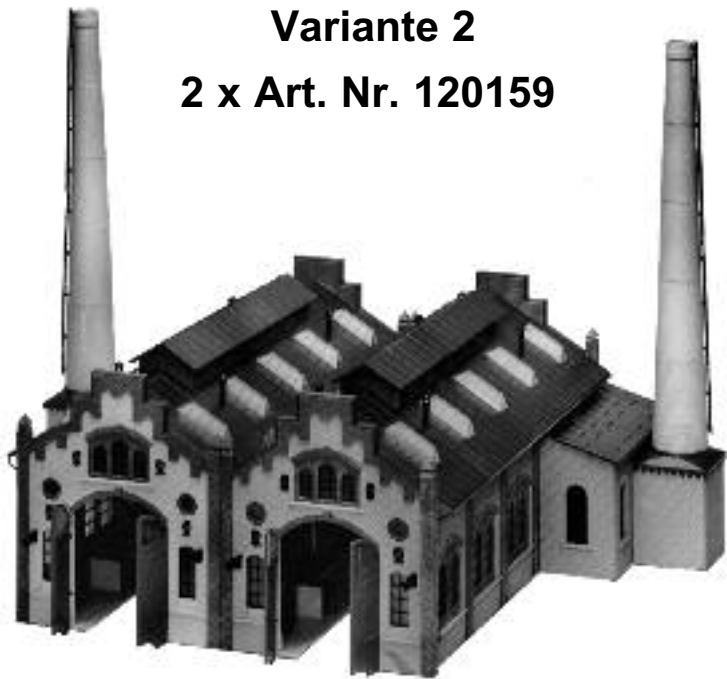

Variante 2
3 x Art. Nr. 120159

Variante 3 **3**



4

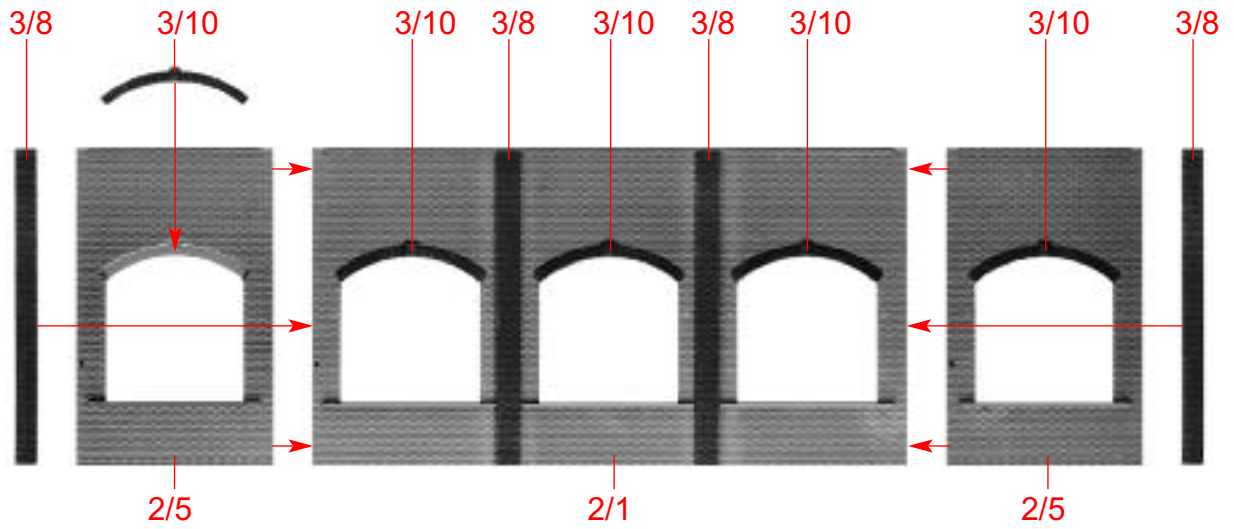

Papiermaske
Papermask
Masque
Masker **M3**

10 x

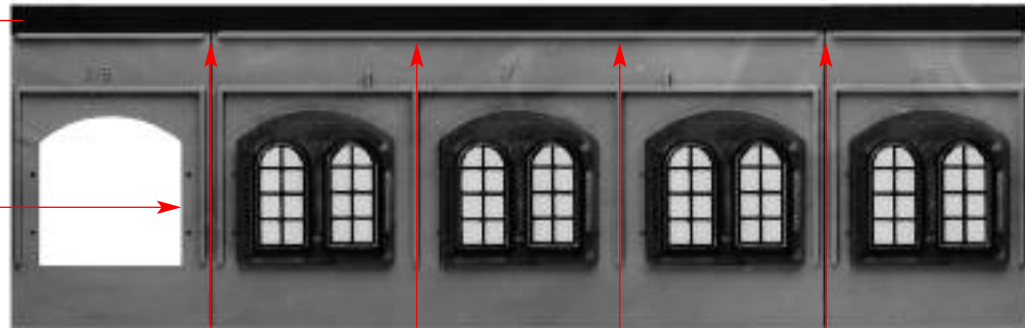
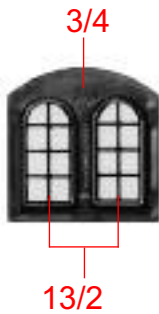

Papiermaske
Papermask
Masque
Masker **M2**



A 2 x

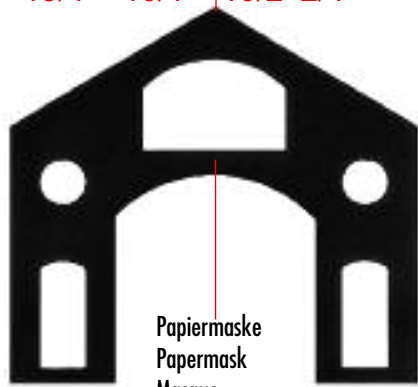
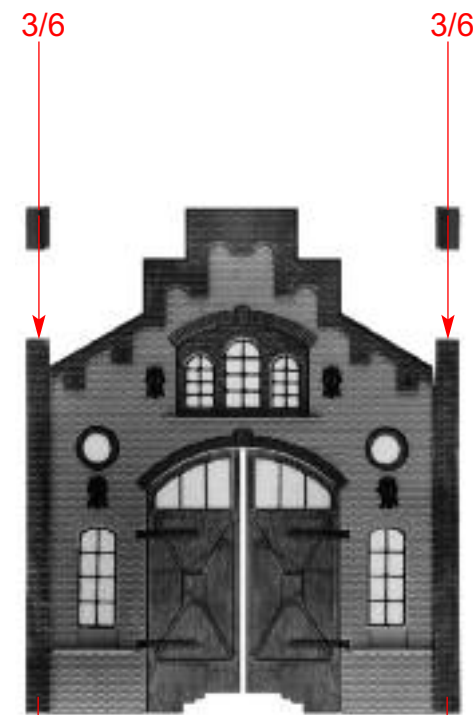
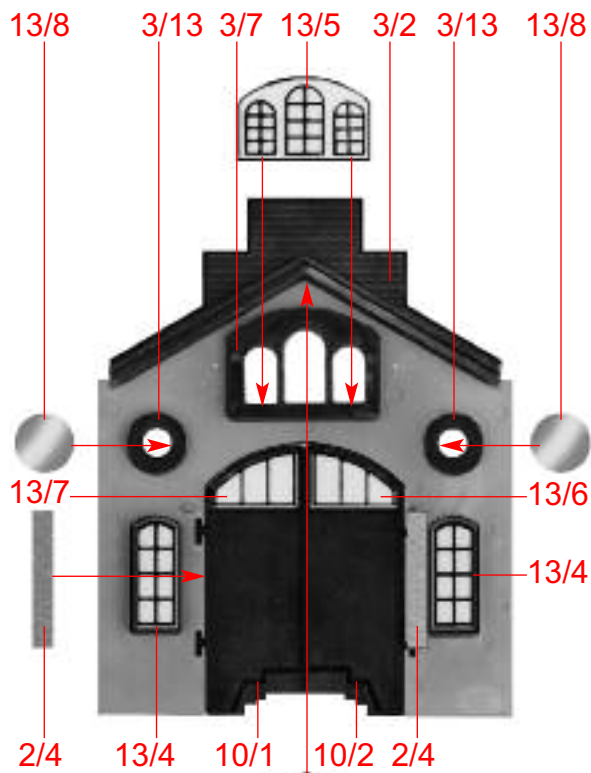
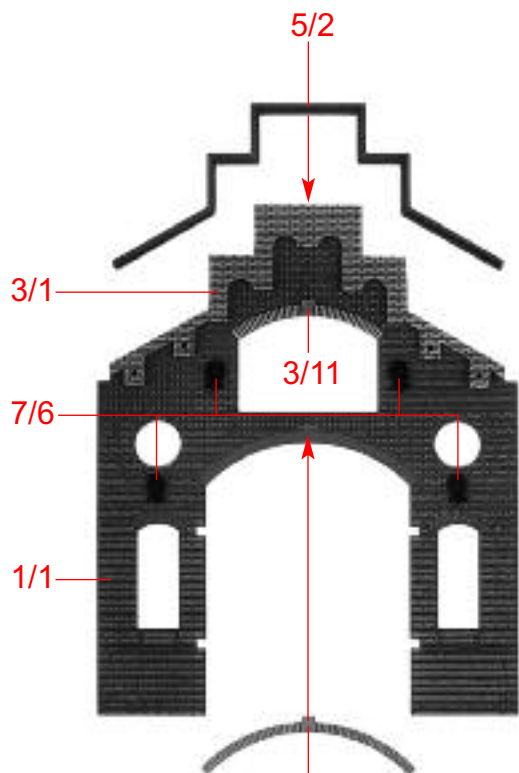

Papiermaske
Papermask
Masque
Masker **M1**

B 2 x

3/9

3/5

3/5

6

4/3

4/1

4/4

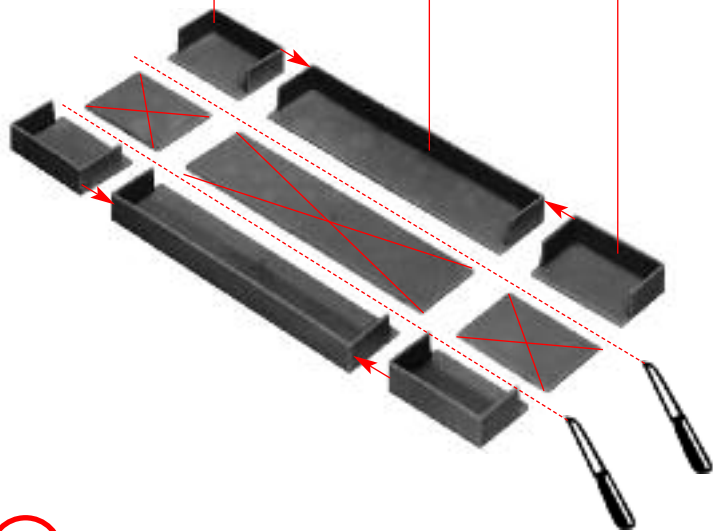

(C)

3/12

(B)

3/12

(A)

4/2

3/12

(B)

3/12

(D)

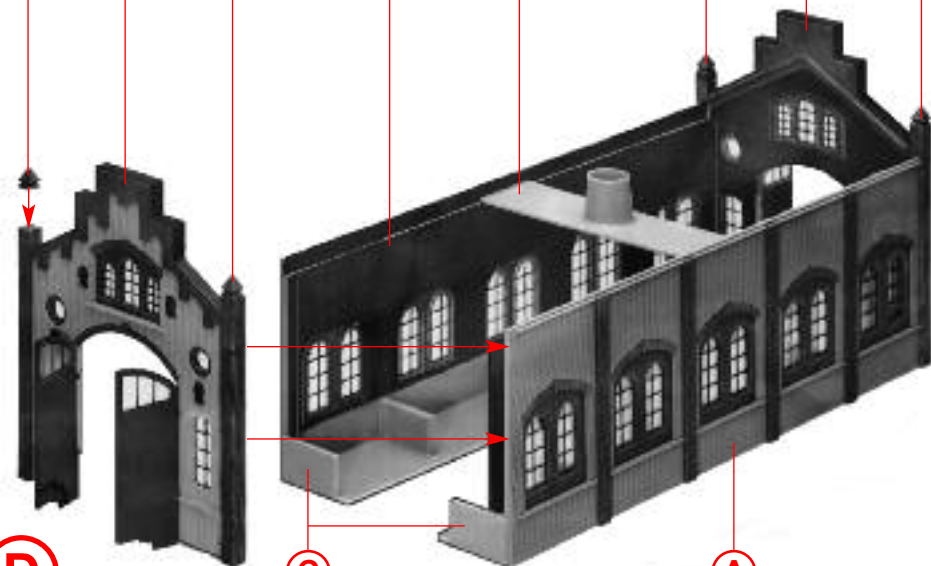

(C)

(A)

13/1

13/1

13/1

13/1

13/1

2 x

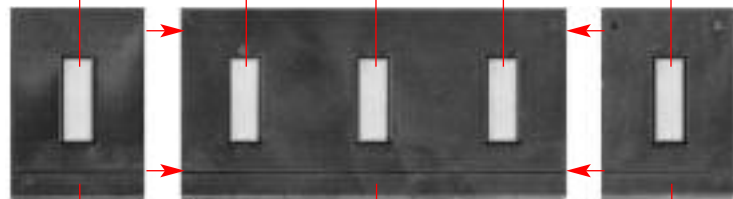

5/4

5/1

5/5

(E)



2/2

2/2

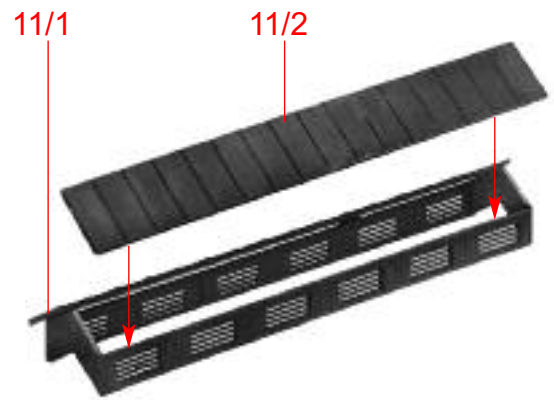
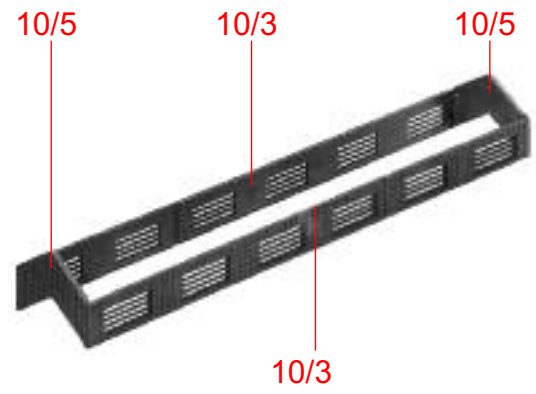

F

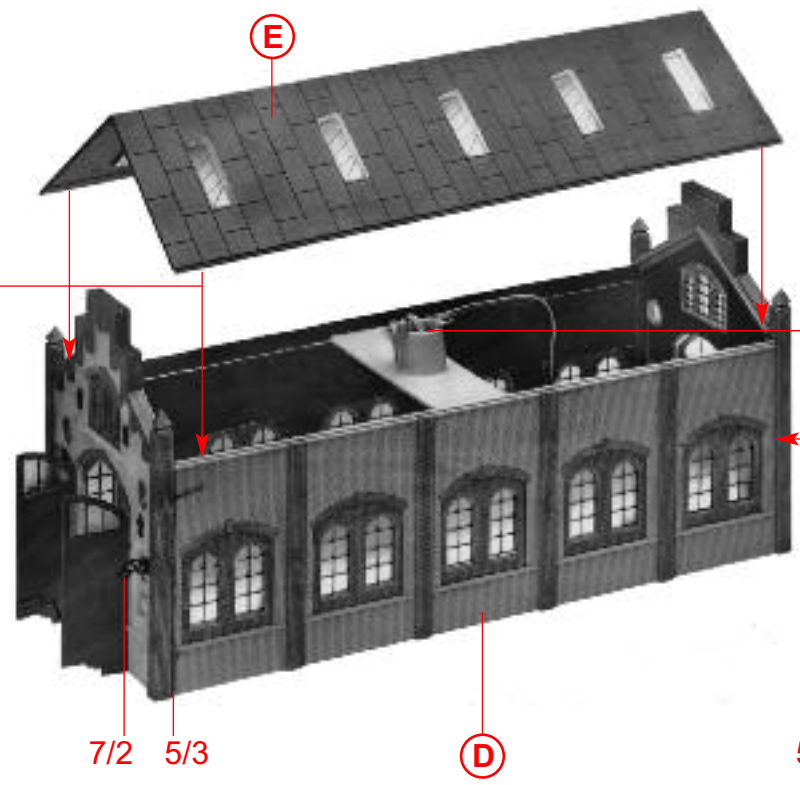

nicht kleben
do not glue
ne pas coller
niet lijmen

Art.-Nr. 180670 liegt nicht bei
not included
non jointe
niet bijgevoegd

G

8

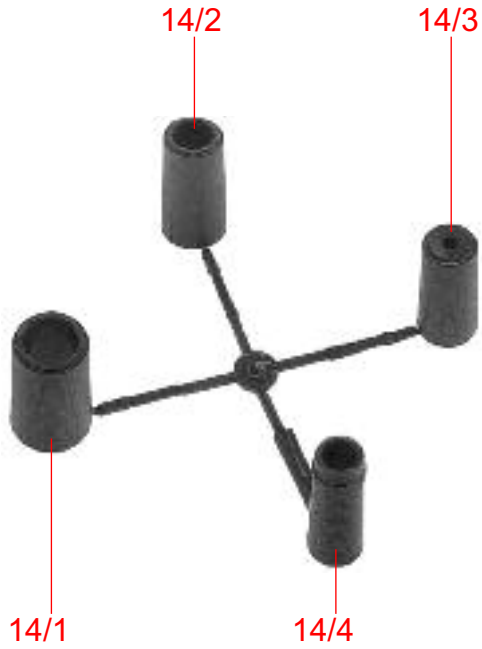

14

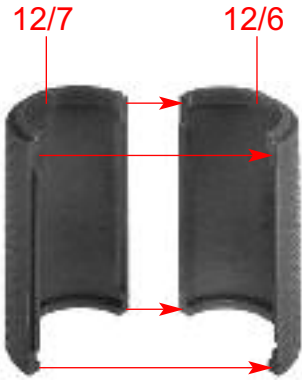

H



I

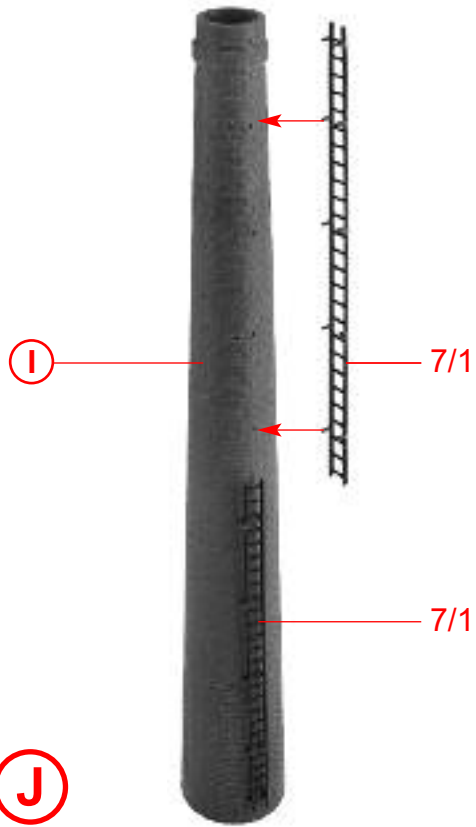

J

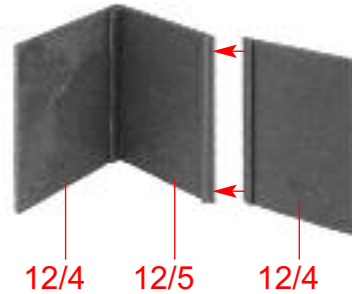

K



L

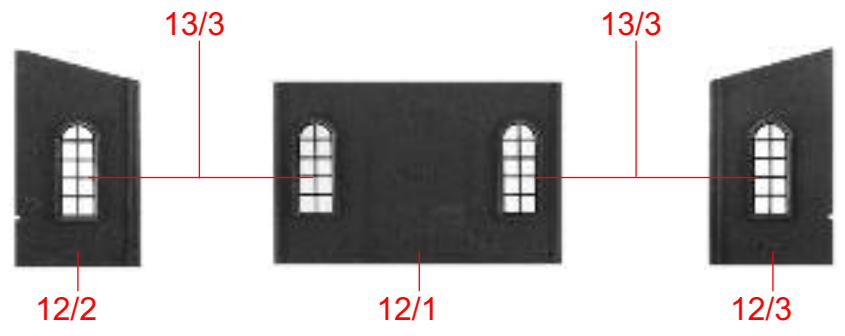

M

N

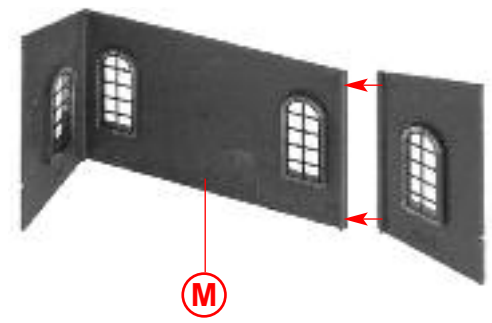

M

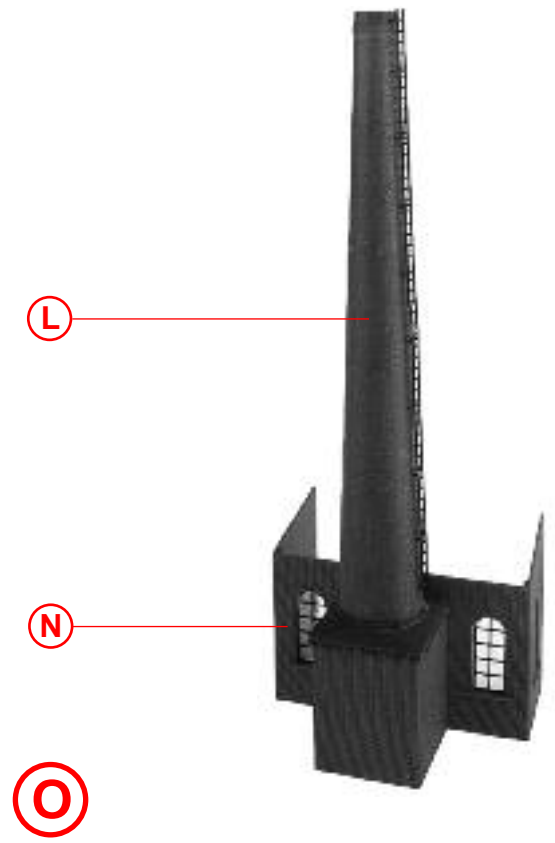

L

N

O



7/7

4 x

7/4

P

5/3

11/3

F

G

O

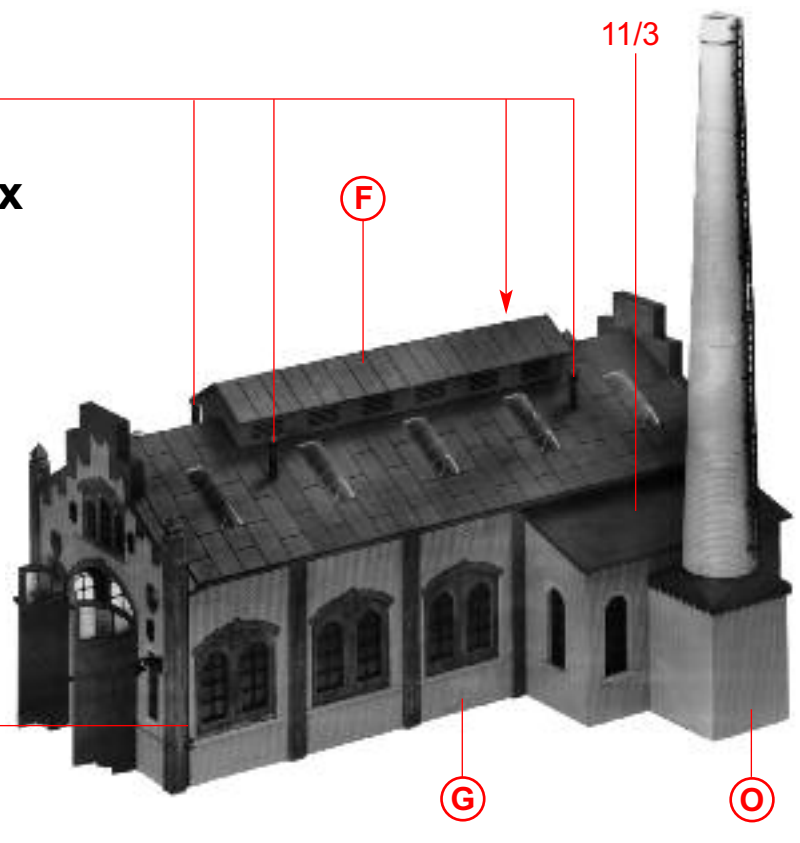

10

- Variante 1: zeigt die Verlängerungsmöglichkeiten der Standardausführung durch Verwendung weiterer Bausätze. Die notwendigen Arbeitsschritte siehe Seite 11-12.
Variante 2: zeigt 2 Hallen nebeneinander gebaut. Hierzu müssen die Dachvorsprünge entlang der Trennkerbe mit einem scharfen Messer abgetrennt werden (siehe Seite 12). Außerdem entfallen bei der Parallelbauweise in den Zwischenwänden sämtliche Fenstereinsätze und Fenster.
Variante 3: durch Versetzen des Werkstattanbaus (mit Kamin) an die Stirnseite, wird ohne Aufwand aus der Lokwerkstatt ein Lokschuppen.

- Variante 1: shows the extension possibility to the standard model by using additional kits. The necessary assembly steps are to be found on page 11-12.
Variante 2: shows 2 halls built next to each other. The roof sides must be trimmed off at the specially provided seam with a sharp modelling knife (see page 12). When building in a parallel manner all window-frames and window glass has to be left off the internal walls.
Variante 3: by placing the work-shed (with chimney) on the narrow side, the repair works will become an engine shed.

- Variante 1: montre les possibilités d'extension de la version standard à l'aide d'autres bâtiments (voir page 11-12).
Variante 2: montre 2 halles côté. L'avancée des toits doit être coupée à l'aide d'un cutter suivant la ligne de coupe (voir page 12). En Autre, en construction de type parallèle, toutes les fenêtres et leurs accessoires disparaissent des cloisons.
Variante 3: en accolant l'atelier (avec cheminée) à la paroi frontale, on obtient à peu de frais une remise à locomotive à partir de l'atelier de réparation.

- Variante 1: toont de mogelijkheid tot verlenging van de standaarduitvoering door gebruik van meerdere bouwpakketten (zie blz. 11-12).
Variante 2: toont 2 naast elkaar gebouwde hallen. Hierbij moeten de uitstekende dakdelen in de scheidingsnaad met een scherp mes worden afgesneden (zie blz. 12). Bovendien vervallen bij parallelle bouwwijze de venter-en raamdelen van de tussenwanden.
Variante 3: door de werkplaatsaanbouw (met schoorsteen) tegen een van de kopwanden te plaatsen, wordt de loc-werkplaats een locloods.

Variante 3



Variante 1

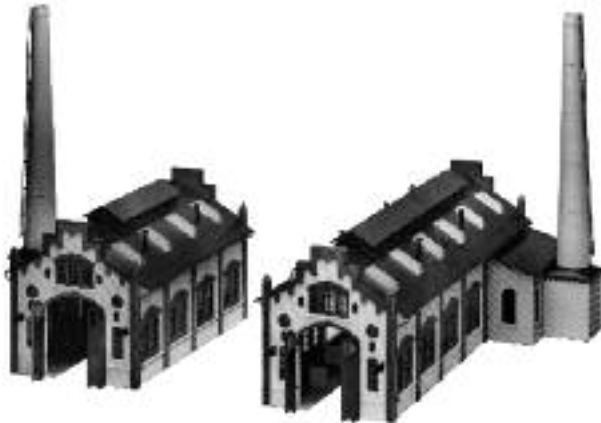

2 x Art. Nr. 120159

Variante 2

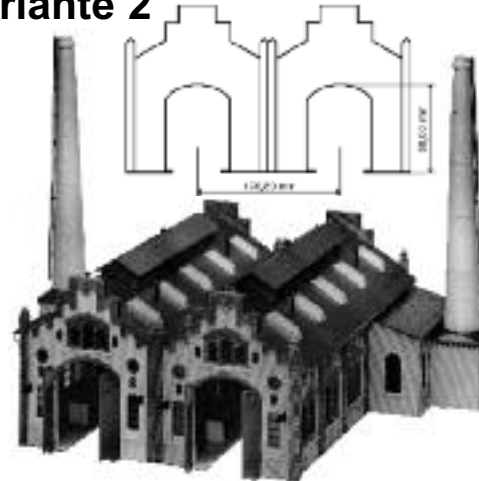

2 x Art. Nr. 120159

Variante 2



3 x Art. Nr. 120159

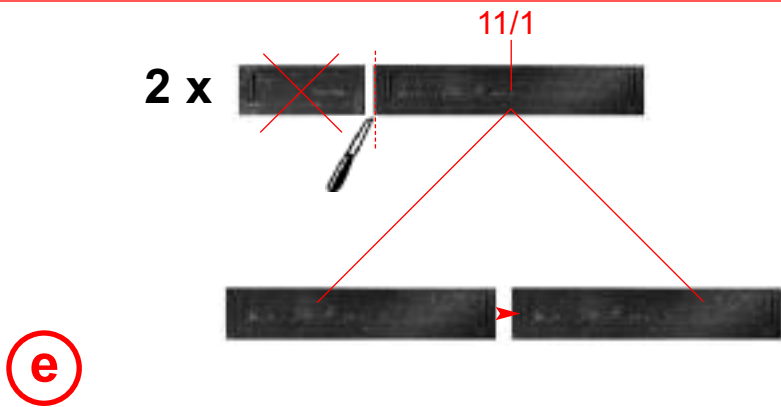
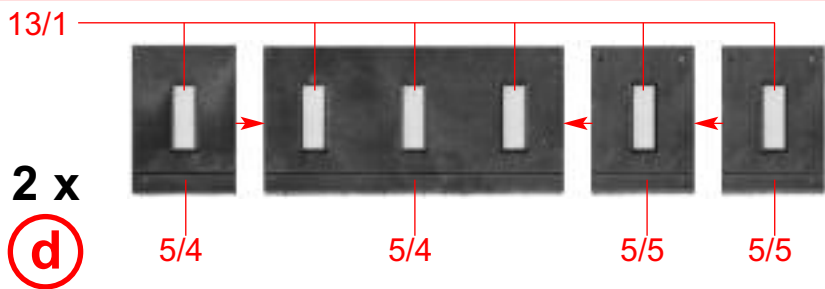
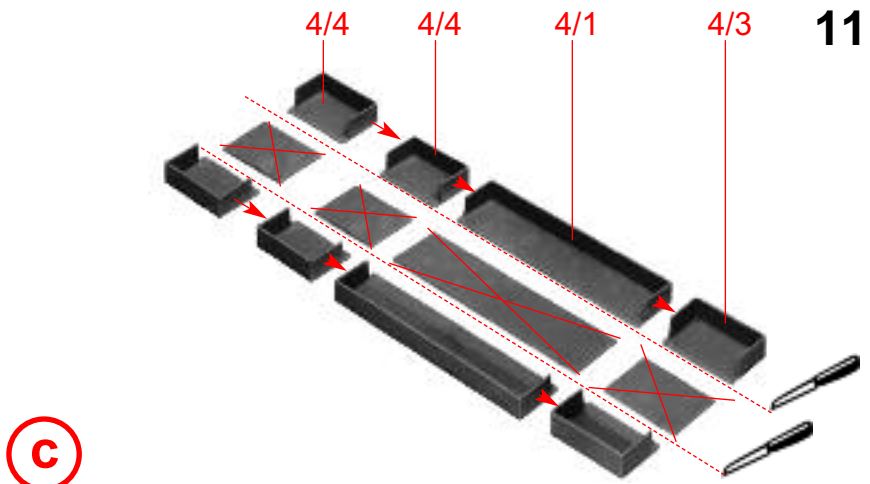
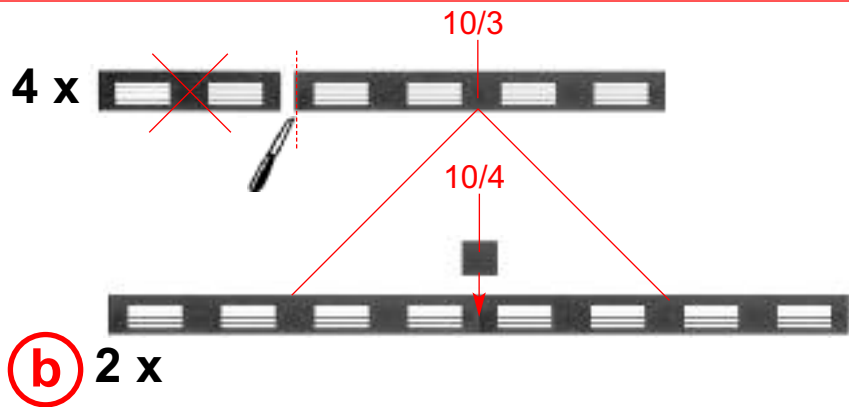
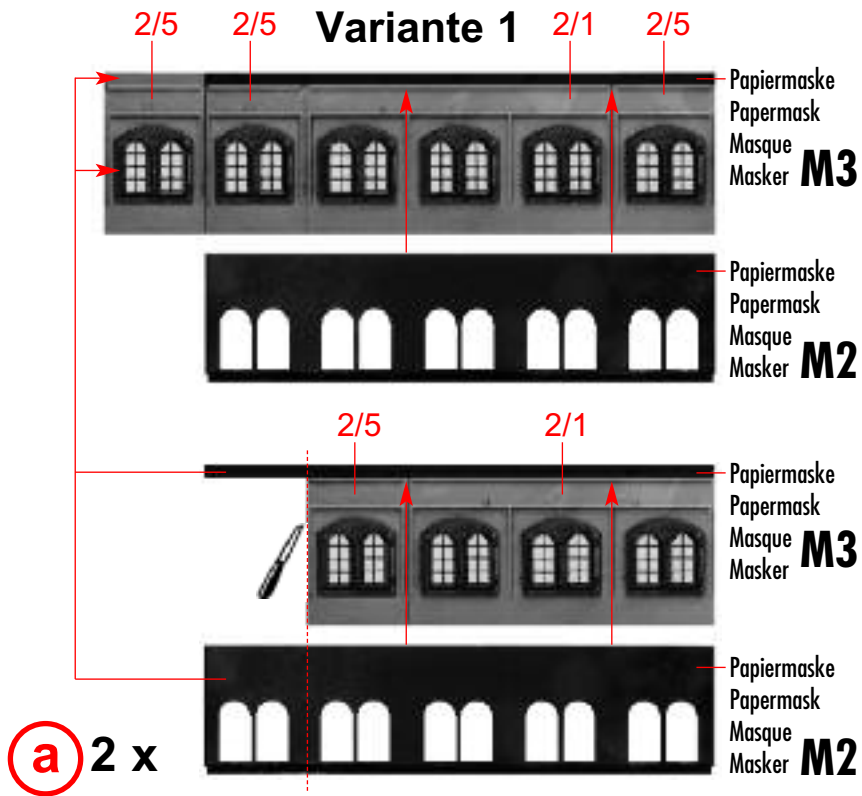

12

2 x

f

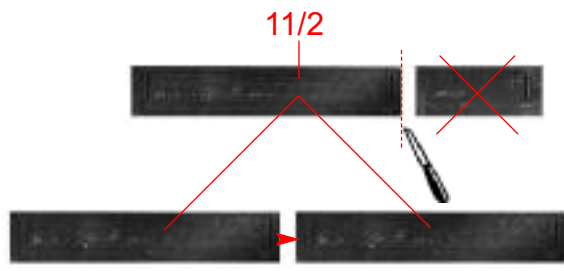

2 x

i

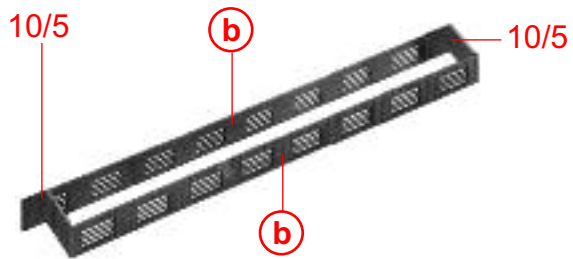
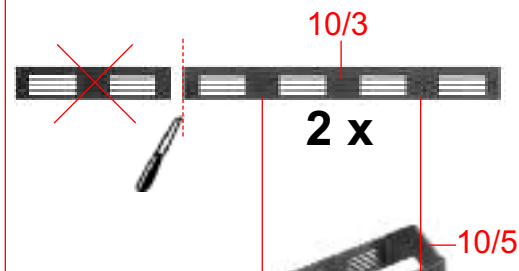
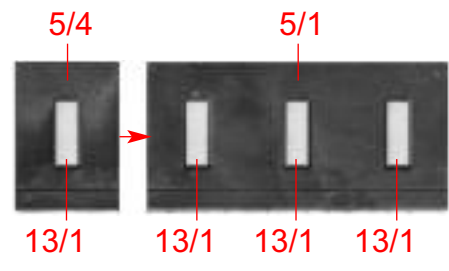

f

e

g

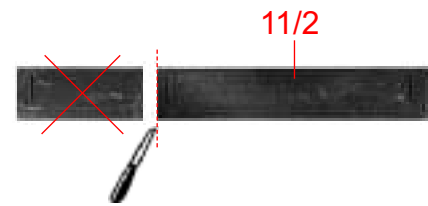
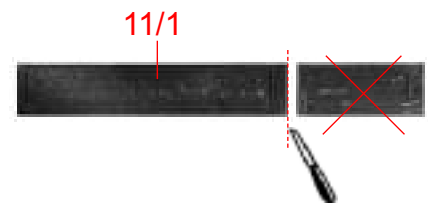

j

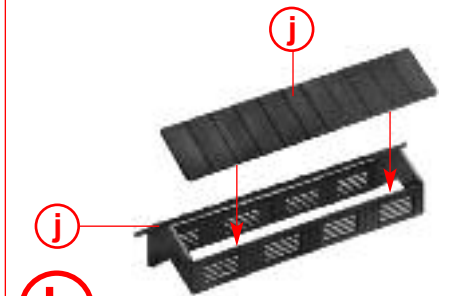

k

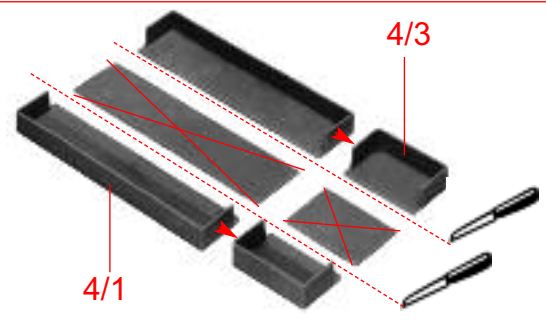

h

Variante 2

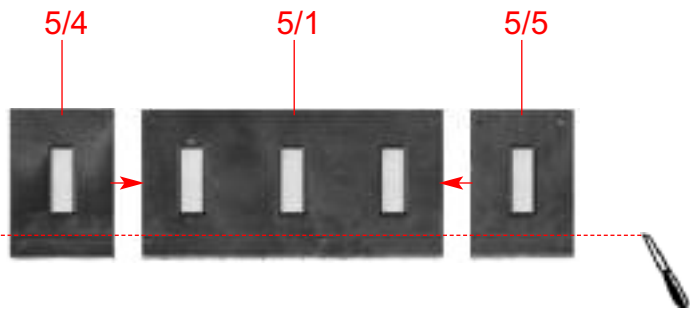

l 2 x